

Embedded Solutions

SD Cards

SD/SDHC410M



Built with top-quality MLC NAND flash chips, Transcend's SD/SDHC410M memory cards can endure operating temperatures from -25°C to 85°C; and set a new standard for consistent, long-term performance even in the harshest conditions. Moreover, these cards offer high-speed data transfer rates to satisfy the demanding performance and reliability requirements of embedded systems, such as transportation, telecommunication, and IoT applications.

Hardware Features

- Compliant with UHS-I
- Compliant with SD specification 5.1
- Compliant with Speed Class 10
- Compliant with Application Performance Class 1 (A1)
- Endurance: 3K P/E cycles (Program/Erase cycles) guaranteed

Firmware Features

- Built-in ECC (Error Correction Code) functionality
- Early Move
- Wear-Leveling

Ordering Information

2GB	TS2GSDC410M
4GB	TS4GSDC410M
8GB	TS8GSDC410M
16GB	TS16GSDC410M
32GB	TS32GSDC410M

*Transcend's SD 410M 2GB features MLC NAND flash, without UHS-I or A1 compliances

Specifications

Appearance	Dimensions	24 mm x 32 mm x 2.1 mm (0.94" x 1.26" x 0.08")
	Weight	2 g (0.04 oz)
	Form Factor	SD flash card
Storage	Flash Type	MLC NAND flash
	Capacity	2 GB / 4 GB / 8 GB / 16 GB / 32 GB
Operating Environment	Operating Voltage	2.7V ~ 3.6V
	Drop Test	1.5m free fall
	Operating Temperature	Standard Temp. -25°C (-13°F) ~ 85°C (185°F)
	Storage Temperature	-40°C (-40°F) ~ 85°C (185°F)
	Humidity	0% ~ 95%
	Shock	Acceleration: 490 m/s ² (standard holding time: 11 ms, semi-sine wave, velocity change: 3.44 m/s)
	Vibration (Operating)	20 G (peak-to-peak), 10 Hz ~ 2,000 Hz (frequency)
Power	Power Consumption (Max.)	0.4 watt(s)
Performance	Read Speed (Max.)	up to 95 MB/s
	Write Speed (Max.)	up to 30 MB/s
	Terabytes Written (TBW)	up to 86 TBW
Warranty	Certificate	CE / FCC / UKCA
	Warranty	Three-year Limited Warranty

Mechanical Dimensions

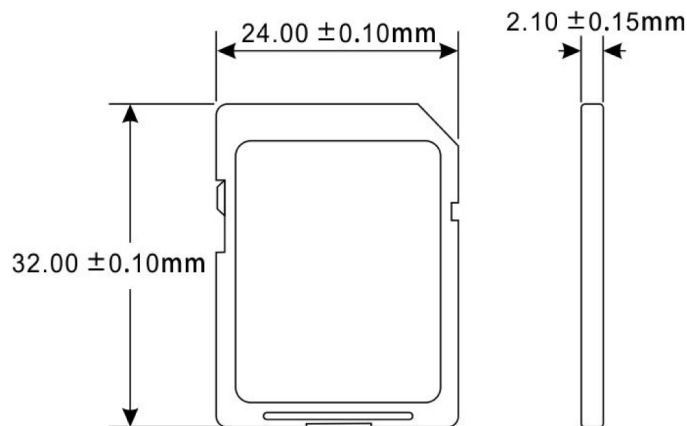

Product specifications are subject to change without notice. Pictures shown may differ from actual products. Total accessible capacity varies depending on operating environment. Due to the complexity and variety of industrial applications, Transcend cannot guarantee 100% compatibility with all platforms and under all scenarios. For special applications and environments, it is strongly suggested that you contact Transcend beforehand for clarification.