

Embedded Solutions



microSD Cards

microSDHC/SDXC420T

Utilizing top-quality 3D NAND Flash and rated to endure 3K P/E cycles, Transcend's microSDXC/SDHC 420T memory cards combine the advantages of high performance and exceptional endurance at an affordable price. They are ideal for write-intensive applications such as medical devices, surveillance systems, and POS terminals, and are compatible with Raspberry Pi products.

*Raspberry Pi is a trademark of Raspberry Pi Trading.

Hardware Features

- Compliant with RoHS 2.0 standards
- Compliant with UHS-I
- Compliant with Speed Class 10
- Compliant with SD specification 5.1
- Compliant with Application Performance Class 1 (A1)

Firmware Features

- Built-in ECC (Error Correction Code) functionality
- Wear-Leveling
- Early Move

*Transcend's microSDHC 420T 16GB features 3D NAND flash, UHS-I, and a 1K P/E cycle endurance rating

Ordering Information

16GB	TS16GUSD420T
32GB	TS32GUSD420T
64GB	TS64GUSD420T
128GB	TS128GUSD420T
256GB	TS256GUSD420T
512GB	TS512GUSD420T

Specifications

Appearance	Dimensions	11 mm x 15 mm x 1 mm (0.43" x 0.59" x 0.04")
	Form Factor	microSD flash card
Storage	Flash Type	3D NAND flash
	Capacity	16 GB / 32 GB / 64 GB / 128 GB / 256 GB / 512 GB
Operating Environment	Operating Voltage	2.7V ~ 3.6V
	Drop Test	1.5m free fall
	Operating Temperature	Standard Temp. -25°C (-13°F) ~ 85°C (185°F)
	Storage Temperature	-40°C (-40°F) ~ 85°C (185°F)
	Humidity	0% ~ 95%
	Shock	Acceleration: 490 m/s ² (standard holding time: 11 ms, semi-sine wave, velocity change: 3.44 m/s)
	Vibration (Operating)	20 G (peak-to-peak), 10 Hz ~ 2,000 Hz (frequency)
Power	Power Consumption (Max.)	0.5 watt(s)
Performance	Read Speed (Max.)	up to 95 MB/s
	Write Speed (Max.)	up to 70 MB/s
	Terabytes Written (TBW)	up to 1,280 TBW
Warranty	Certificate	CE / FCC / UKCA
	Warranty	Three-year Limited Warranty

Mechanical Dimensions

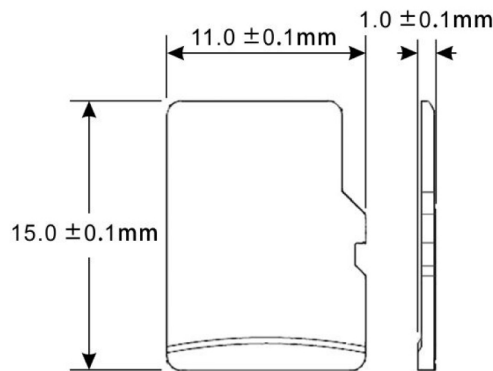

Product specifications are subject to change without notice. Pictures shown may differ from actual products. Total accessible capacity varies depending on operating environment. Due to the complexity and variety of industrial applications, Transcend cannot guarantee 100% compatibility with all platforms and under all scenarios. For special applications and environments, it is strongly suggested that you contact Transcend beforehand for clarification.